

FIXMAT®

**Catálogo
2026**

**Herramientas y
fijaciones**

PERNOS - TUERCAS - GOLILLAS

PERNO ANCLAJE DE FIJACION CORRIENTE ZINCADO



SKU	MEDIDA	SKU	MEDIDA
339014	1/4 X 1 3/4	399424	1/2 x 3 3/4
399018	1/4 X 2 1/4	399434	1/2 x 4 1/4
399040	1/4 X 3 1/4	399444	1/2 x 5 1/2
399118	5/16 X 2	399448	1/2 x 6
399122	5/16 X 2 3/4	399456	1/2 x 7
399138	5/16 X 3 3/16	399528	5/8 x 3 1/2
399160	5/16 X 4 1/4	399536	5/8 x 4 1/2
399222	3/8 x 2 3/4	399540	5/8 x 5
399224	3/8 x 3	399548	5/8 x 6
399230	3/8 x 3 3/4	399672	3/4 x 8 1/2
399240	3/8 x 5	399692	1/2 x 8

BARRAS ROSCADAS POR METRO G2 UNC ZINC



SKU	MEDIDA	SKU	MEDIDA
700007	3/16	700021	5/8
700009	1/4	700025	3/4
700011	5/16	700029	7/8
700013	3/8	700033	1
700017	1/2		

TUERCA HEXAGONAL GRADO 2 UNC ZINC



SKU	MEDIDA	SKU	MEDIDA
500008	1/8	500034	1/2
500012	3/16	500044	5/8
500015	1/4	500052	3/4
500022	5/16	500060	7/8
500026	3/8	500070	1
500028	7/16	500081	1 1/4

TUERCA HEXAGONAL SEGURO NYLON UNC ZINCADA



SKU	MEDIDA	SKU	MEDIDA
505416	1/4	505440	5/8
505420	5/16	505448	3/4
505424	3/8	505456	7/8
505428	7/16	505464	1
505432	1/2	505480	1 1/4

GOLILLA PLANA CORRIENTE ZINC



SKU	MEDIDA	SKU	MEDIDA
740218	1/4	740250	3/4
740222	5/16	740258	7/8
740226	3/8	740266	1
740230	7/16	740274	1 1/8
740234	1/2	740282	1 1/4
740238	9/16	740298	1 1/2
740242	5/8		

GOLILLA PRESION ZINCADA



SKU	MEDIDA	SKU	MEDIDA
741018	1/4	741038	9/16
741022	5/16	741042	5/8
741026	3/8	741048	3/4
741030	7/16	741060	7/8
741034	1/2	741068	1

GOLILLA VULCANIZADA AC/ EPDM ZINC



SKU	MEDIDA	SKU	MEDIDA
740330	10 X 5.1 X 14	740334	14 X 7.0 X 16
740332	12 X 6.1 X 14		

TORNILLOS MADERA – METAL - CLAVOS

TORNILLO VOLCANITA PHILLIPS CRS ZINC



SKU	MEDIDA	SKU	MEDIDA
649924	6 x 3/4"	649964	6 x 2"
649932	6 x 1"	649972	6 x 2 1/4"
649940	6 x 1 1/4"	649996	8 x 3"
649952	6 x 1 5/8"		

TORNILLO TURBO SCREW PUNTA TORX T30 DICROMATO



SKU	MEDIDA	SKU	MEDIDA
648650	6 x 120	648665	6 x 180
648655	6 x 140	648670	6 x 200
648660	6 x 160		

TORNILLO TURBO SCREW PTA POZIDRIV DICROMATO



SKU	MEDIDA	SKU	MEDIDA
649010	3.0 X 12"	649154	4.5 x 30"
649014	3.0 X 16"	649158	4.5 x 35"
649016	3.0 X 20"	649162	4.5 x 40"
649022	3.0 x 25"	649166	4.5 x 50"
649050	3.5 x 20"	649170	4.5 x 60"
649054	3.5 x 25"	649174	4.5 x 70"
649058	3.5 x 30"	649220	5.0 x 50"
649062	3.5 x 40"	649224	5.0 x 60"
649110	4.0 x 20"	649228	5.0 x 70"
649114	4.0 x 30"	649320	6.0 x 80"
649118	4.0 x 40"	649328	6.0 X 100"
649122	4.0 x 50"	649336	6.0 x 120"
		649344	6.0 x 140"

TORNILLO AUTOP. CAB. TRUSS (LENTEJA) PTA BROCA ZINC



SKU	MEDIDA	SKU	MEDIDA
651516	8 X 1/2"	651532	8 X 1"
651524	8 X 3/4"	651540	8 X 1 1/4"

TORNILLO AUTOP. CAB. TRUSS (LENTEJA) PTA FINA ZINC



SKU	MEDIDA	SKU	MEDIDA
651617	8 X 1/2"	651632	8 X 1"
651625	8 X 3/4"	651641	8 X 1 1/4"

TORNILLO AUTOP. HEX. C/GOLILLA ACERO Y EPDM PTA BROCA ZINC



SKU	MEDIDA	SKU	MEDIDA
641120	10 X 5/8"	641396	12 X 3"
641124	10 X 3/4"	641424	14 X 3/4"
641132	10 X 1"	641432	14 X 7/8"
641148	10 X 1 1/2"	641440	14 X 1"
641164	10 X 2"	641444	14 X 1 1/4"
641220	12 X 5/8"	641448	14 X 1 1/2"
641224	12 X 3/4"	641464	14 X 2"
641332	12 X 1"	641480	14 X 2 1/2"
641340	12 X 1 1/4"	641496	14 X 3"
641348	12 X 1 1/2"	641512	14 X 3 1/2"
641364	12 X 2"	641528	14 X 4"
641380	12 X 2 1/2"	641544	14 X 4 1/2"

TORNILLO AUTOP. HEX. C/GOLILLA ACERO Y EPDM PTA FINA ZINC



SKU	MEDIDA	SKU	MEDIDA
652272	#12 X 2	652290	#10-12 X 2
652282	#10-12 X 3/4	652291	#10-12 X 2 1/2
652284	#10-12 X 1	652292	#10-12 X 3
652286	#10-12 X 1 1/2		

TORNILLO TIRAFONDO HEXAGONAL ZINC



SKU	MEDIDA	SKU	MEDIDA
603236	1/4 X 1	603564	5/16 x 2
603244	1/4 X 1 1/4	603580	5/16 x 2 1/2
603252	1/4 x 1 1/2	603600	5/16 x 3
603270	1/4 x 2	603616	5/16 x 3 1/2
603284	1/4 x 2 1/2	603632	5/16 x 4
603300	1/4 x 3	603648	5/16 x 4 1/2
603316	1/4 x 3 1/2	603664	5/16 x 5
603332	1/4 x 4	603696	5/16 x 6
603348	1/4 x 4 1/2	603852	3/8 x 1 1/2
603360	1/4 x 5	603868	3/8 x 2
603544	5/16 x 1 1/4	603884	3/8 x 2 1/2
603552	5/16 x 1 1/2		

TORNILLO AUTOP. FIBROCEMENTO PTA FINA ZINC



SKU	MEDIDA	SKU	MEDIDA
641844	8 X 1 1/4	641944	9 X 1 1/4

TORNILLO AUTOP. C/WAFER FIBROCEMENTO PTA BROCA ZINC



SKU	MEDIDA	SKU	MEDIDA
642032	6 X 1 1/4	642044	8 X 1 1/4

TORNILLO AUTOP. C/AVELLANADA FIBROCEMENTO ZINC



SKU	MEDIDA
-----	--------

642048	8 X 1 1/4
--------	-----------

TORNILLO MADERA AGLOMERADA CABEZA PLANA RANURA PH ZINC



SKU	MEDIDA	SKU	MEDIDA
-----	--------	-----	--------

593316	3 X 12
593416	3.5 X 12
593419	3.5 X 15
593420	3.5 X 16
593424	3.5 X 20
593432	3.5 X 25

593448	3.5 X 40
593524	4 X 20
593570	4 X 60
593648	4.5 X 40
593670	4.5 X 60
593776	5 X 70

TORNILLO MADERA SOBERBIO PUNTA POZI ZINC



SKU	MEDIDA	SKU	MEDIDA
-----	--------	-----	--------

601993	10 X 1 1/2
--------	------------

640864	12 X 2
--------	--------

TORNILLO AUTOP. POLYCARBONATO METAL C/GOL. EPDM ZINC

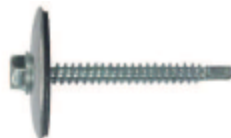

SKU	MEDIDA	SKU	MEDIDA
-----	--------	-----	--------

640848	12 X 1 1/2
--------	------------

640864	12 X 2
--------	--------

TORNILLO AUTOP. POLYCARBONATO MADERA C/GOL. EPDM ZINC



SKU	MEDIDA
-----	--------

652308	12 X 2
--------	--------

TORNILLO PARA PLASTICO CAB. TRUSS PH ZINC



SKU	MEDIDA
-----	--------

651720	4 X 20
--------	--------

651726	4 X 40
--------	--------

CLAVO CORRIENTE



SKU	MEDIDA	SKU	MEDIDA
-----	--------	-----	--------

	1 1/2"
--	--------

FCBM-001	2"
----------	----

	2 1/2"
--	--------

FCBP-001	3"
----------	----

FCBQ-001	4"
----------	----

FCBR-001	5"
----------	----

	6"
--	----

--	--

REMACHE CIEGO (POP) ALUMINIO



SKU	MEDIDA	SKU	MEDIDA
752227	3.2 X 10	752827	4.8 X 10
752230	3.2 X 11	752830	4.8 X 11
752233	3.2 X 12	752833	4.8 X 12
752239	3.2 X 14	752836	4.8 X 13
752248	3.2 X 17	752839	4.8 X 14
752533	4.0 X 12	752845	4.8 X 16
752536	4.0 X 13	752851	4.8 X 18
752539	4.0 X 14	752854	4.8 X 19
752545	4.0 X 16	752857	4.8 X 20
752551	4.0 X 18	752860	4.8 X 22
752554	4.0 X 19	752866	4.8 X 24
752557	4.0 X 20	752869	4.8 X 25
752563	4.0 X 22	752884	4.8 X 30

GANCHOS - SOPORTES - ABRAZADERAS - CANCAMO - TENSOR - OTROS

GANCHO J ZINC



SKU	MEDIDA	SKU	MEDIDA
675064	2	675096	3
675080	2 1/2	675128	4

CANCAMO ABIERTO ZINCADO



SKU	MEDIDA	SKU	MEDIDA
998055	3 3/8	998075	4 7/16
998065	3 7/8		

CANCAMO CERRADO ACERO ZINCADO



SKU	MEDIDA	SKU	MEDIDA
998120	1/4 X 3	998145	5/16 X 4
998125	1/4 X 3 3/4	998150	5/16 X 6
998140	1/4 X 5	998160	3/8 X 3 1/4
998143	5/16 X 3 1/4	998165	3/8 X 4 1/2

GANCHO HAMACA ROSCA MADERA ZINCADO



SKU	MEDIDA
-----	--------

998100	3 3/4
--------	-------

GANCHO HAMACA CON SOPORTE



SKU	MEDIDA
-----	--------

998110	5/16 X 3 1/2
--------	--------------

PERNO OJO CON TUERCA ACERO ZINCADO



SKU	MEDIDA	SKU	MEDIDA
-----	--------	-----	--------

998180	3/8 X 2 1/2
998190	3/8 X 4
998195	3/8 X 5
998200	3/8 X 6
998210	3/8 X 8

998225	1/2 X 4
998235	1/2 X 6
998245	1/2 X 8
998255	1/2 X 10
998265	1/2 X 12

ARGOLLA AMARRA CABO C/PLATINA ACERO ZINCADO



SKU	MEDIDA
-----	--------

998392	2 X 1/4
--------	---------

TENSOR OJO - OJO ACERO ZINCADO



SKU	MEDIDA	SKU	MEDIDA
-----	--------	-----	--------

998450	5/32 X 4 3/8
998452	3/16-24 X 5 5/8
998453	3/16 X 6 3/8
998456	1/4 X 7 3/8

998459	5/16 X 8 7/8
998462	3/8 X 10 5/8
998465	3/8 X 16 1/4
998470	1/2-13 X 19 1/2

TENSOR GANCHO - OJO ACERO ZINCADO



SKU	MEDIDA	SKU	MEDIDA
-----	--------	-----	--------

998475	5/32 X 4 3/8
998478	3/16-24 X 6 3/8
998481	1/4 X 7 3/8
998484	5/16 X 8 7/8

998487	3/8 X 10 5/8
998490	3/8 X 16 1/4
998495	1/2-13 X 19 1/2

TORNILLO ESCUADRA ACERO BRONCEADO



SKU	MEDIDA	SKU	MEDIDA
-----	--------	-----	--------

021110	1 3/8
021114	1 1/2

021118	2
021122	2 1/4

CABLE DE ACERO GALVANIZADO 6*19 + FC



SKU	MEDIDA	SKU	MEDIDA
-----	--------	-----	--------

003624	1/4
003626	5/16
003628	3/8

003630	7/16
003632	1/2

CABLE DE ACERO GALVANIZADO 6 * 7 + FC + PVC



SKU	MEDIDA	SKU	MEDIDA
-----	--------	-----	--------

003642	3/32-1/8
003644	1/8-3/16

003646	5/32-3/16
003648	3/16-1/4

CABLE DE ACERO PIOLA TRUPER



SKU	MEDIDA
-----	--------

1044207	Diámetro: 1/4" Carga trabajo: 2240 kg
---------	--

CABLE DE ACERO PIOLA FORRO PVC TRUPER



SKU	MEDIDA
1044218	Diámetro: 1/4" Carga trabajo: 2240 kg

ABRAZADERA MANGUERA DICROM



SKU	MEDIDA	SKU	MEDIDA
999334	1/2"	999335	5/8"
999336	3/4"	999337	7/8"

ABRAZADERA TUBULAR + TOPE



SKU	MEDIDA	SKU	MEDIDA
003664	1/16	003671	5/32
003667	3/32	003672	3/16
003668	1/8	003674	1/4

ABRAZADERA FIERRO PARA CLABLE DE ACERO

FIERO



SKU

MEDIDA

1044082	1/8 – 2PZS
1044083	3/16 – 2PZS
1044084	1/4 – 2PZS
1044085	5/16 - 2PZS
1044086	3/8 – 1PZ
1044087	1/2 – 1PZ

IMPORPER



SKU

MEDIDA

998602	1/8
998604	3/16
998606	1/4
998608	5/16
998610	3/8
998612	7/16
998614	1/2
998616	9/16
998618	5/8
998620	3/4
998622	7/8
998624	1

ABRAZADERA PARA CABLE (PIOLA) GALVANIZADO



SKU	MEDIDA	SKU	MEDIDA
998652	1/4	998666	3/4
998654	5/16	998668	7/8
998656	3/8	998670	1
998660	1/2	998672	1 1/8
998664	5/8	998674	1 1/4

ROLDANA SIMPLE CON DESTORCEDOR



SKU	MEDIDA	SKU	MEDIDA
997956	1/2 CABLE 3/16	997971	1 1/2 CABLE 3/8
997959	3/4 CABLE 1/4	997975	2"
997965	1 CABLE 5/16		

DESTORCEDOR MOSQUETON GIRATORIO CROMADO

FIERO



SKU

MEDIDA

1044029	2" – 70Kg
1044030	3" – 82Kg
1044031	3 1/2 – 103Kg
1044032	4" – 114Kg
1044033	4 1/4 – 191Kg

IMPORPER



SKU

MEDIDA

998955	LINEA 5025 3/8
998958	LINEA 5025 1/2
998960	LINEA 5025 5/8
998962	LINEA 5025 3/4
998964	LINEA 5025 1
998980	LINEA 437 3/8
998981	LINEA 437 BC 3/4

DESTORCEDOR ZINC METALICO PARA CABLE

FIERO



SKU

MEDIDA

1044098	5/32 – 40KG
1044099	3/16 – 70KG
1044100	1/4 - 70KG
1044101	5/16 – 70KG

IMPORPER



SKU MEDIDA

998811	3/8
998813	1/2
998815	5/8
998816	3/4
998818	1
998820	1 1/4

DESTORCEDOR FORJADO

TRUPER



SKU MEDIDA

1044105	3/16 / 350KG
1044106	1/4 / 390 KG
1044107	5/16 / 570 KG
1044108	3/8 / 1020KG

IMPORPER



SKU MEDIDA

	1/4
	5/16
	3/8
	1/2

BANDOLA MOSQUETON ACERO

FIERO



SKU MEDIDA

1044037	3/16 X 2
1044038	1/4 X 2 1/2
1044039	5/16 X 3
1044040	3/8 X 4
1044041	1/2 X 5 1/2

IMPORPER



SKU	MEDIDA
-----	--------

998742	5 x 50
998744	6 x 60
998746	7 x 70
998748	8 x 80
998750	10 x 100

GANCHO S ABIERTO ACERO ZINCADO

FIERO



SKU	MEDIDA
-----	--------

1044091	3/16 – 13K
1044092	1/4 – 38KG
1044093	5/16 – 75KG

IMPORPER



SKU	MEDIDA
-----	--------

998320	2 3/16
998325	3

GANCHO ESLINGA ACERO FORJADO

FIERO



SKU	MEDIDA
-----	--------

1044075	3/4 – 500KG
1044076	5/8 – 1000KG
1044077	5/8X – 1500KG
1044078	5/8XX – 2000KG

ESLABON UNION DE CADENA ACERO C/SEGURO

FIERO



SKU MEDIDA

1044020	1/8 X 1 1/2 – 100K
1044021	3/16 X 2 – 900K
1044022	1/4 X 2 1/2 – 400K
1044023	5/16 X 3 – 800K
1044024	3/8 X 3 1/2 – 1200k
1044025	1/2 x 4 – 1500k

IMPORPER



SKU MEDIDA

998382	1/8
998384	3/16
998386	1/4

PICAPORTE RED. B. RECTA BRONCE C/TORNILLOS



SKU MEDIDA

021434	1 1/2
021436	2

SKU MEDIDA

021438	2 1/2
--------	-------

BISAGRA CUADRADA ACERO LATON CABEZA REDONDA C/TORNILLOS

HERMEX



SKU

MEDIDA

1043230	2
1043231	2 1/2
1043232	3
1043233	3 1/2
1043234	4

BISAGRA RECTANGULAR ACERO LATON C/TORNILLOS

HERMEX



SKU

MEDIDA

1043192	1 X 7/8
1043193	1 1/2 X 1 3/16
1043194	2 X 1 1/2
1043195	2 1/2 X 15/8
1043196	3 X 2
1043197	3 1/2 X 2 1/8
1043198	4 X 2 3/4

CANDADOS

CANDADO HERMEX



SKU

MEDIDA

1123518	40 mm
1123519	50 mm

- Nivel de seguridad: Básico (1, 2, 3)
- Cuerpo de hierro acabado color latón
- Gancho corto de acero con acabado cromado
- Cilindro metálico con 3, 4 y 5 pernos de combinación
- Mecanismo interno resistente a la corrosión

SET CANDADO BRONCE 4 PZS HERMEX



SKU

MEDIDA

1043445

40 mm

- Nivel de seguridad: Alta (5)
- Cilindro de latón sólido, seguro tipo perno, seguridad estándar
- Gancho anti-robo con un recubrimiento especial que permite resistir actos vandálicos (cortes de segueta, corta pernos y perforaciones)

BROCAS – GUIA SIERRA COPA – TARUGOS – PUNTAS – LLAVES

BROCA CONCRETO-CORTA DIN 8039



SKU	MEDIDA	SKU	MEDIDA
016530	3	016570	7
016540	4	016580	8
016550	5	016600	10
016560	6	016620	12

BROCA MADERA METRICA



SKU	MEDIDA	SKU	MEDIDA
016880	6	016884	10
016882	8	016886	12

BROCA HSS FRESADA NEGRA - PULGADA



SKU	MEDIDA	SKU	MEDIDA
015504	1/16	015524	3/8
015510	5/32	015532	1/2
015512	3/16	015536	9/16
015516	1/4	015540	5/8
015520	5/16		

BROCA CONCRETO-CORTA DIN 8039



SKU	MEDIDA	SKU	MEDIDA
016530	3	016570	7
016540	4	016580	8
016550	5	016600	10
016560	6	016620	12

BROCA HSS TOMA REDUCIDA 13 MM DIN 338



SKU	MEDIDA	SKU	MEDIDA
016470	17	016490	19
016475	17.5	016500	20
016480	18		

BROCA CONCRETO SDS PLUS



SKU	MEDIDA	SKU	MEDIDA
016806	L110 6.0MM	016838	L210 8.0MM
016818	L160 8.0MM	016840	L210 10MM
016820	L160 10MM	016842	L210 12MM
016822	L160 12MM	016846	L210 16MM
016823	L160 13MM		

BROCA HSS FRESADA NEGRA - METRICA



SKU	MEDIDA	SKU	MEDIDA
-----	--------	-----	--------

015610	1
015615	1.5
015620	2
015625	2.5
015630	3
015635	3.5
015640	4
015645	4.5
015650	5
015655	5.5
015660	6
015665	6.5
015670	7
015675	7.5
015680	8
015685	8.5
015690	9
015700	10
015705	10.5

015710	11
015715	11.5
015720	12
015725	12.5
015730	13
015735	13.5
015740	14
015745	14.5
015750	15
015755	15.5
015760	16
015765	16.5
015770	17
015775	17.5
015780	18
015785	18.5
015790	19
015795	19.5
015800	20

GUIA SIERRA COPA BI-METAL HSS

NEXXO



SKU

MEDIDA

10JNEXGC14	12 A 32MM
10JNEXGC32	32 A 210MM

BROCA PILOTO AVELLANADORA

IMPORPER



SKU

MEDIDA

017128	#8
017130	#10-3/16 X 1 1/2
017132	#12

BROCA PLANA PALETA PARA MADERA

IMPORPER/EURODRILL



SKU

MEDIDA

016856	3/8
016858	1/2
016860	5/8
016862	3/4
016864	7/8
016866	1
016868	1 1/4
016870	1 1/2

TRUPER



SKU

MEDIDA

1011360	1/4
1011363	5/16
1011366	3/8
1011369	7/16
1011372	1/2
1011375	5/8
1011378	3/4
1011381	7/8
1011384	1
1011387	1 1/8
1011390	1 1/4
1011393	1 1/2

JUEGO 6 PZS. BROCAS PLANAS PALETA

SKU

MEDIDA

1011395	1
	7/8
	3/4
	5/8
	1/2
	3/8

TRUPER



JUEGO 9 PZS. BROCAS PARA METAL – CONCRETO - MADERA

SKU	MEDIDA
1011339	MADERA
	7/32
	3/16
	5/32
	CONCRETO
	3/16
	1/4
	5/16
	METAL
5/32	
3/16	
7/32	

TRUPER



JUEGO 9 PZS. BROCAS PARA METAL – CONCRETO - MADERA

SKU	MEDIDA
1011336	METAL
	3/16
	1/4
	1/8
	CONCRETO
	3/16
	1/4
	3/8

TRUPER



JUEGO 8 PZS. BROCAS PARA MADERA

SKU	MEDIDA
-----	--------

1011338	1/8
	5/32
	3/16
	7/32
	1/4
	9/32
	5/16
	3/8

TRUPER



JUEGO 6 PZS BROCAS MADERA

TRUPER



SKU	MEDIDA
-----	--------

1011337	1/8
	5/32
	3/16
	1/4
	9/32
	5/16

JUEGO 5 PZS BROCAS MULTIPROPOSITO. MADERA/METAL/PLASTICO

TRUPER



SKU

MEDIDA

1011394	1/4 3/16 1/8 3/32 1/16
---------	------------------------------------

BROCA PARA VIDRIO Y AZULEJO PUNTA TUGNSTENO

SKU

MEDIDA

1011700	1/8
1011701	3/16
1011702	1/4
1011703	5/16
1011704	3/8
1011705	1/2

TRUPER

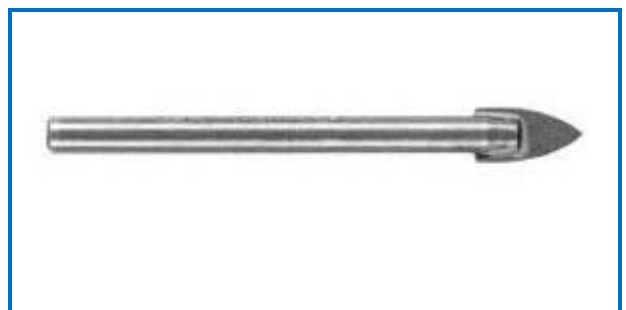

SKU	MEDIDA
-----	--------

750250	3/8"
750252	5/8"

SKU	MEDIDA
-----	--------

750254	1/8"
--------	------

TARUGO NYLON EXP. IMPORPER



TARUGO PALOMA NYLON VOLCANITA, IMPORPER



TARUGO PALOMA NYLON INTERNIT. IMPORPER



SKU	MEDIDA
-----	--------

750110	N 204
750115	N 205
750120	N 206
750125	N 208
750130	N 210
750135	N 212

TARUGO NYLON EXP.C/TOPE, IMPORPER



SKU	MEDIDA
-----	--------

750150	N206
750155	N208

TARUGO MADERA IMPORPER



SKU	MEDIDA
-----	--------

002807	10x45mm
002808	12x45mm
002805	6x45mm
002806	8x45mm

PUNTA TORX T30

SKU	MEDIDA
-----	--------

014803	PUNTA TORX T30
--------	----------------

IMPORPER

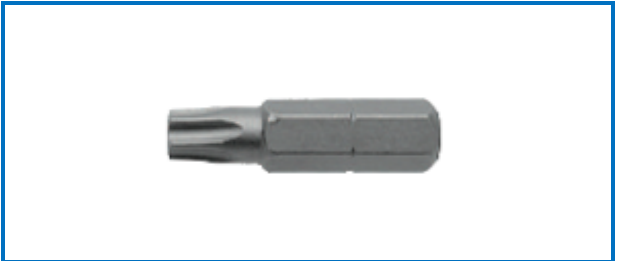

SKU	MEDIDA
-----	--------

1017813	7 PZS. TS10 TS15 TS20 TS25 TS27 TS30 TS40
---------	--

TRUPER



PUNTA POZIDRIV

SKU	MEDIDA
-----	--------

014821	N1 1/4X25MM
014822	N2 1/4X25MM
014823	N3 1/4X25MM
014826	N1 1/4X50MM
014827	N2 1/4X50MM
014828	N3 1/4X50MM

SKU	MEDIDA
-----	--------

1012162	5 PZS/ PZ2 - LARGO 50MM
---------	----------------------------

IMPORPER



TRUPER



PUNTA ALLEN

SKU	MEDIDA
-----	--------

014841	3mm (1/8 X 50 mm)
--------	-------------------

IMPORPER



SKU	MEDIDA
-----	--------

014851	N1 1/4X25MM
014852	N2 1/4X25MM
014853	N3 1/4X25MM
014857	N1 1/4X50MM
014858	N2 1/4X50MM
014859	N3 1/4X50MM

SKU	MEDIDA
-----	--------

1012141	PH2 1/4X25MM - 5PZS
1012147	PH2 1/4X50MM - 5PZS
1012149	PH3 1/4X50MM - 5PZS

IMPORPER



TRUPER



PUNTA DADO HEXAGONAL IMANTADA PULGADA

SKU	MEDIDA
-----	--------

014875	7/32 X 45MM
014876	1/4X45MM
014877	5/16X45MM
014879	3/8X45MM

SKU	MEDIDA
-----	--------

1012939	1/4 - 5PZS
1012940	3/8 - 5PZS
1012942	5/16 - 5PZS

IMPORPER

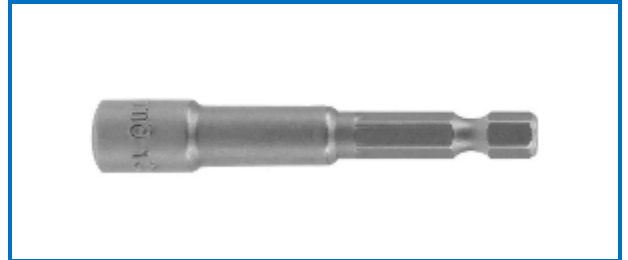

TRUPER

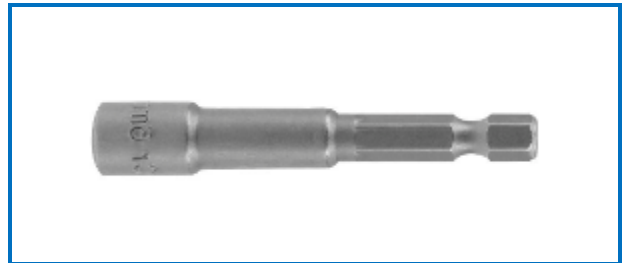

LLAVES ALLEN MILIMETRICAS TIPO NAVAJA 8PZS

TRUPER



SKU	MEDIDA
-----	--------

1015555	1.5mm
	2mm
	2.5mm
	3mm
	4mm
	5mm
	6mm
	8mm

LLAVES ALLEN MILIMETRICAS TIPO NAVAJA 9PZS

TRUPER



SKU

MEDIDA

1015563

1.3mm

1.5mm

2mm

2.5mm

3mm

4mm

5mm

5.5mm

6mm

LLAVES ALLEN EXTRA LARGAS MILIMETRICAS 7PZS

TRUPER



SKU

MEDIDA

1015548

2.5mm

3mm

4mm

5mm

6mm

8mm

10mm

LLAVES ALLEN EXTRA LARGAS PULGADAS 7PZS

TRUPER

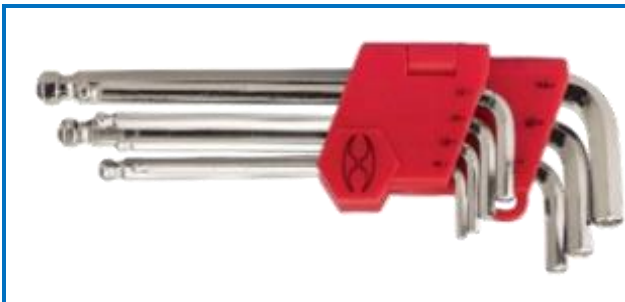

SKU

MEDIDA

1015551

1/8"

5/32"

3/16"

7/32"

1/4"

5/16"

3/8"

LLAVES ALLEN 13PZS

TRUPER



SKU

MEDIDA

1015542

1.3mm – 1.5mm – 2mm
2.5mm – 3mm – 3.5mm
4mm – 4.5mm – 5mm
5.5mm – 6mm – 8mm
10mm

LLAVE TORX 9PZS

TRUPER



SKU

MEDIDA

1015554

T10 – T15
T20 – T25
T27 – T30
T40 – T45
T50

LLAVE TORX TIPO NAVAJA 8PZS

TRUPER



SKU

MEDIDA

1015569

T9 – T10
T15 – T20
T25 – T27
T30 – T40

LLAVES TORX LARGAS 7PZS

TRUPER



SKU

MEDIDA

1015553	T10
	T15
	T20
	T25
	T27
	T30
	T40

DISCO DE CORTE, MULTIPROPOSITO, FLAP, DESBATE Y GRATAS

SKU	MEDIDA
-----	--------

21DCCA6000	4 ½ X 1 mm
------------	------------

SKU	MEDIDA
-----	--------

1012545	4 ½ X 1 mm
---------	------------

1012546	7 X 1,5 mm
---------	------------

- Discos abrasivos para corte extrafino de metal, alta durabilidad
- Cortes extrafinos de metal, alta durabilidad
- Fabricados de óxido de aluminio

SKU	MEDIDA
-----	--------

10TCT04512M	4 ½ X 1,2 mm
-------------	--------------

DISCO CORTE FINO INOX. ECO. NEXXO



DISCO CORTE FINO METAL. TRUPER



DISCO CORTE MULTIPROPÓSITO NEXXO



SKU	MEDIDA
-----	--------

070NXDCP45	4 ½ X 1,2 mm
------------	--------------

SKU	MEDIDA
-----	--------

070NXDCV45	4 ½ X 1,2 mm
------------	--------------

SKU	MEDIDA
-----	--------

021DDCA5060	4 ½ X 6 mm
-------------	------------

DISCO CORTE PORCELANATO NEXXO



DISCO CORTE VIDRIO NEXXO



DISCO DESBATE PREMIUM NEXXO



SKU	MEDIDA
-----	--------

21DFRA4560	4 ½ GRANO 60
21DFRA4580	4 ½ GRANO 80
21DFRA4510	4 ½ GRANO 100
21DFRA4520	4 ½ GRANO 120

SKU	MEDIDA
-----	--------

21DFCP4560	4 ½ GRANO 60
21DFCP4580	4 ½ GRANO 80

SKU	MEDIDA
-----	--------

1011674	4 ½ GRANO 60
1011688	4 ½ GRANO 80

DISCO FLAP ECO NEXXO



DISCO FLAP PREMIUM NEXXO



DISCO FLAP LAMINADO TRUPER



SKU	MEDIDA
-----	--------

76861291633219	DIAMETRO 4" (100 mm)
----------------	-------------------------

SKU	MEDIDA
-----	--------

10GPT45AC	DIAMETRO 4 ½" (115mm)
-----------	--------------------------

SKU	MEDIDA
-----	--------

10100851	ESPELOR: 19/32" CALIBRE 0,335 mm (0,014")
----------	--

- Fabricada en acero al carbono
- Acabado rugoso
- Multi-rosca 5/8"-11 y M14 compatible con otras marcas del mercado y con esmeriladoras Truper[®] y Pretul[®]
- Para trabajo pesado y desbaste rápido

GRATA COPA TRENZADA CARBONO NEXXO



GRATA CIRCULAR PLANA TRENZADA NEXXO



CARDA COPA 3" ALAMBRE TRENZADO FINO, MULTIROSCA, TRUPER



ELECTRODO SOLDADURA

HYUNDAI



SKU

MEDIDA

37HYD60101K	6010 3/32"
37HYD60111K	6011 3/32"
37HYD30112K	6011 1/8"
37HYD70181K	7018 3/32"
37HYD70182K	7018 1/8"

SOLDADURA ESTAÑO PLOMO CON NÚCLEO RESINA 50/50

TRUPER



SKU

MEDIDA

1014365	450 g
---------	-------

- Resistencia a alta presión y temperatura
- Para instalaciones hidráulicas de agua fría y caliente, plomería en general, tuberías de cobre y hojas de metal

ADAPTADORES COPA – CORTADOR TUBO - VIDRIO

JUEGO DE SIERRA COPA DE ACERO AL CARBONO, 15 PZAS, PRETUL



JUEGO DE 14 PIEZAS SIERRA COPA BIMETÁLICAS, TRUPER



SKU	MEDIDA
-----	--------

1126037	Brocasiera 3/4" Brocasiera 7/8" Brocasiera 1" Brocasiera 1 1/8" Brocasiera 1 1/4" Brocasiera 1 3/8" Brocasiera 1 1/2" Brocasiera 1 3/4" Brocasiera 2" Brocasiera 2 1/2" Brocasiera 2 1/4" Brocasiera 3" Mandril de 3/8" Mandril de 5/16" Llave Allen
---------	--

- Brocasiera y mandriles fabricados de acero al carbono

SKU	MEDIDA
-----	--------

1015411	11 Brocasieras: 3/4", 7/8", 1", 1 1/8", 1 1/4", 1 3/8", 1 1/2", 1 3/4", 2", 2 1/4" y 2 1/2" 2 Mandriles de 3/8" y 7/16"
---------	---

- Brocasieras bimetálicas 10X mayor durabilidad que las de acero al carbono
- Dientes de acero alta velocidad para cortes 2X más rápidos
- Ranura amplia para fácil extracción de residuos
- Estuche con broches metálicos

JUEGO DE 8 PIEZAS SIERRA COPA BIMETÁLICAS, TRUPER



JUEGO DE 3 PIEZAS PARA INSTALAR CERRADURAS, TRUPER



JUEGO DE 3 PIEZAS PARA INSTALAR CERRADURAS, PRETUL



SKU	MEDIDA
-----	--------

1015405	6 Brocasieras: 3/4", 7/8", 1 1/8", 1 1/2", 1 3/4" y 2 1/4" Mandriles 7/16"
---------	--

- 10x Mayor durabilidad que las de acero al carbono
- Dientes de acero alta velocidad
- Ranura amplia para remover material fácilmente
- Estuche con broches metálicos

SKU	MEDIDA
-----	--------

10100816	1 Brocasierra de 2 1/8" 1 Brocasierra de 1" 1 Mandril de 3/8" con adaptador para 7/16"
----------	--

- Brocasieras bimetálicas 10X mayor durabilidad que las de acero al carbono
- Dientes de acero alta velocidad para cortes 2X más rápidos
- Ranura amplia para fácil extracción de residuos

SKU	MEDIDA
-----	--------

1123549	Brocasierra 2 1/8" Mandril de 3/8" Broca de manita 7/8"
---------	---

- Broca sierra de acero al carbono

JUEGO DE 5 PIEZAS SIERRA COPA PARA MADERA, PRETUL



SKU	MEDIDA
-----	--------

1123550	Brocasierra 1 1/4" Brocasierra 1 1/2" Brocasierra 2" Brocasierra 2 1/8" Mandril de 3/8"
---------	---

- Sierra y mandril fabricados en acero al carbono

CORTADOR DE TUBO COBRE

TRUPER



SKU	MEDIDA
-----	--------

1012853	2" – 51mm
---------	-----------

- Cuchillas de acero de alta aleación
- Removedor retráctil de rebabas
- Cuchilla adicional incluida en la perilla
- Para cortes limpios en cobre, latón o aluminio

CORTADOR TUBO PVC – PPR

TRUPER



SKU	MEDIDA
-----	--------

1012867	2 1/2" – 64mm
---------	---------------

- Cuchilla de acero inoxidable
- Cuerpo de aluminio
- Sistema de matraca
- Apertura automática
- Corta CPVC, PP-R, POLY y manguera de goma

CORTADOR DE VIDRIO CUCHILLA DIAMANTE

TRUPER



SKU

MEDIDA

1012953

Hasta 6mm

- Cuchilla de carburo de tungsteno que facilita el corte
 - 3 ranuras de recorte
 - Diseño de dientes para remover bordes ásperos
- Exclusivamente corte de vidrio

ALICATES – PINZAS – DESTORNILLADORES

ALICATE PELACABLES MANUAL

SKU	MEDIDA
-----	--------

1017356	6" Corta y pela cable de 22 a 10 AWG
---------	--------------------------------------

TRUPER



- Acabado niquelado
- Para pelar cables trenzados calibres de 22 a 10 AWG
- Cuchillas de corte y punta delgada para lugares de difícil acceso
- Resorte de auto apertura y seguro

ALICATE PONCHADORA MODULOS INTERCAMBIABLES

SKU	MEDIDA
-----	--------

1018343	Para instalar conectores: RJ-9, RJ-11, RJ-12 y RJ-45
---------	--

TRUPER



ALICATE PROFESIONAL CABEZA CUADRADA

SKU	MEDIDA
1017303	7"
1017304	8"
1017305	9"

TRUPER



ALICATE DE CORTE DIAGONAL

SKU	MEDIDA
1017312	6"
1017313	7"

TRUPER



ALICATE DE PUNTA Y CORTE

SKU	MEDIDA
1017309	6"
1017315	7"
1017310	8"

TRUPER



ALICATE DE ELECTRICISTA – CONFORT GRIP – 1000V

SKU	MEDIDA
1017329	7"
1017330	8"

TRUPER



Alicate Corte Diagonal – Confort Grip – 1000V

SKU	MEDIDA
-----	--------

1017331	6"
---------	----

TRUPER



Alicate de Punta y Corte – Confort Grip – 1000V

SKU	MEDIDA
-----	--------

1017334	6"
1017336	8"

TRUPER



Alicate Tradicional – Confort Grip

SKU	MEDIDA
-----	--------

1122674	8"
---------	----

PRETUL



ALICATE DE CORTE DIAGONAL – CONFORT GRIP

SKU	MEDIDA
-----	--------

1122675	6"
---------	----

PRETUL



ALICATE DE CORTE DIAGONAL – CONFORT GRIP

SKU	MEDIDA
-----	--------

1122675	6"
---------	----

PRETUL



ALICATE DE PUNTA Y CORTE – CONFORT GRIP

SKU	MEDIDA
-----	--------

1122670	6"
1122671	8"

PRETUL



SKU	MEDIDA
-----	--------

1122966	<ul style="list-style-type: none"> • 1 alicate de electricista 8" (20 cm) • 1 alicate de punta y corte 6" (15 cm) • 1 alicate de corte diagonal 6" (15 cm)
---------	---

- Fabricadas en acero al carbono
- Mangos cubiertos de PVC con topes que evitan el deslizamiento de la mano

PRETUL



ALICATE DE EXTENSION (PICOLORO)

SKU	MEDIDA
-----	--------

1017350	8"
1017351	10"
1017352	12"

TRUPER



PINZA SACABOCADOS CON GRIP TRUPER

SKU	MEDIDA
-----	--------

1017340	9" (23 cm)
---------	------------

- Para perforaciones en cuero, lona, plástico y cartón
- Depósito de desperdicio
- Mango recubierto de vinil para mayor comodidad

PRETUL



PINZA PELACABLES AUTOMÁTICA

SKU	MEDIDA
-----	--------

1017360	8"- 22 A 10 AWG
---------	-----------------

TRUPER



PINZAS PARA TIERRA SOLDADURA

SKU	MEDIDA
-----	--------

1014235	500 A
---------	-------

- Fabricadas con lámina de acero galvanizada
- Conexiones y mordazas de latón para máxima conductividad eléctrica
- Resortes de alta presión para asegurar el contacto

TRUPER



DESTORNILLADOR PTA CRUZ – MANGO CONFORT GRIP

TRUPER



SKU

MEDIDA

1014055	1/8X4
1014064	3/16X3
1014067	3/16X6
1014082	1/4X8
1014076	1/4X4
1014079	1/4X6

DESTORNILLADOR PTA PALETA – MANGO CONFORT GRIP

TRUPER



SKU

MEDIDA

1014003	1/4X1 1/2
1014992	3/16X4
1014000	1/4X6
1014006	5/16X6
1013998	1/4X4

DESTORNILLADOR DIELECTRICO PTA CRUZ

TRUPER



SKU

MEDIDA

10102240	3/16 X 3
10102241	1/4 X 4

DESTORNILLADOR DIELECTRICO PTA CRUZ

TRUPER



SKU

MEDIDA

10102242

7/32 x 5

10102243

1/4 x 6

SET DESTORNILLADORES 3/16 CORTO – MANGO CONFORT GRIP

TRUPER



SKU

MEDIDA

1019624

3/16X4 – 2PZS

JUEGO DE 5 DESARMADORES MANGO GRIP

TRUPER



SKU

MEDIDA

1014138

- 1 Desarmador punta de cruz (3/16" x 3")
- 1 Desarmador punta de cruz (1/4" x 4")
- 1 Desarmador punta plana (1/4" x 6")
- 1 Desarmador punta plana (3/16" x 4")
- 1 Desarmador punta cabinet (3/16" x 4")

Barras hexagonales fabricadas de acero al cromo vanadio 2x más resistentes al desgaste que las de acero al carbono

JUEGO 6 DESARMADORES DIELECTRICOS Y 1 PROBADOR DE CORRIENTE

TRUPER



SKU

MEDIDA

1014196

- 1 Desarmador punta plana (1/8" x 4")
- 1 Desarmador punta plana (5/32" x 4")
- 1 Desarmador punta plana (7/32" x 5")
- 1 Desarmador punta plana (1/4" x 6")
- 1 Desarmador punta de cruz (3/16" x 3")
- 1 Desarmador punta de cruz (1/4" x 4")
- 1 Probador de corriente

- Desarmadores con puntas de acero al cromo vanadio 2X más resistentes al desgaste que las de acero al carbono
- Aislamiento que protege contra descargas eléctricas, resisten hasta 1,000 V
- Mangos ergonómicos antiderrapantes
- Probador para circuitos de 100 - 250 V
- Para trabajos con voltajes vivos

JUEGO DE 4 DESARMADORES MANGO GRIP

PRETUL



SKU

MEDIDA

1120218

- 1 Desarmador punta plana 3/16" x 4" (4.7x101.6mm)
- 1 Desarmador punta plana 1/4" x 4" (6.3x101.6mm)
- 1 Desarmador punta de cruz 3/16" x 4" (4.7x101.6mm)
- 1 Desarmador punta de cruz 1/4" x 4" (6.3x101.6mm)

JUEGO 6 PZS DESTORNILLADOR DE PRECISION

TRUPER



SKU

MEDIDA

1014202

- 01 DESARMADOR PLANO 1.8MM
- 02 DESARMADOR CRUZ PH00 A PH0
- 02 DESARMADOR TORX T4 Y T5
- 01 DESARMADOR TRIWING Y000

JUEGO DESTORNILLADOR 77 PZS PARA REPARACION ELECTRONICA

TRUPER

SKU

MEDIDA

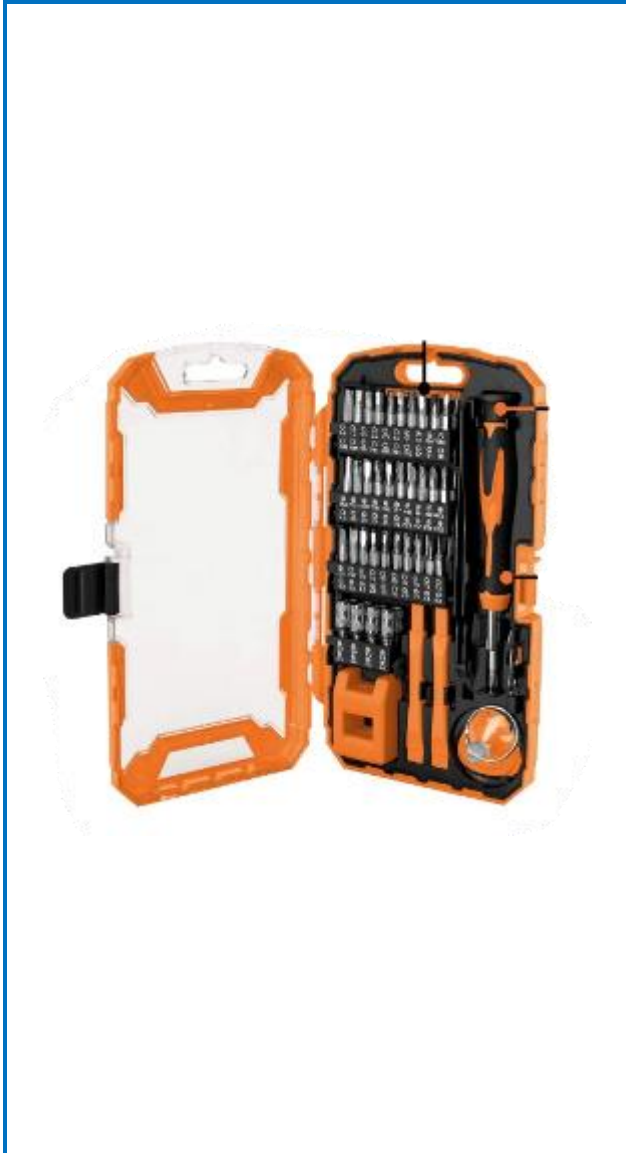

10100373

- 06 PTAS PLANAS 1 A 4 mm
- 05 PTAS CRUZ PH000 A PH2
- 09 TORX T2 A T10
- 06 TORX CON SEGURO TT7 A TT20
- 08 HEXAGONAL 0.9 A 4 mm
- 07 HEXAGONAL 1/16 A 5/32
- 04 ESTRELLAS 0.8 A 2 mm
- 04 TRIWING TRI000 A TRI1
- 04 TRIANGULO 2 A 3MM
- 04 POZIDRIV PZ00 A PZ2
- 01 SPANNER
- 03 CUADRADAS SO A S2
- 08 DADOS 2.5 A 5.5 mm
- 03 ESPATULAS
- 01 PINZA CURVA
- 01 MAGNETIZADOR
- 01 MANGO
- 01 LLAVE PARA SIM
- 1 VENTOSA PARA PANEL

JUEGO DESTORNILLADOR TIPO MATRACA 58 PZS

TRUPER

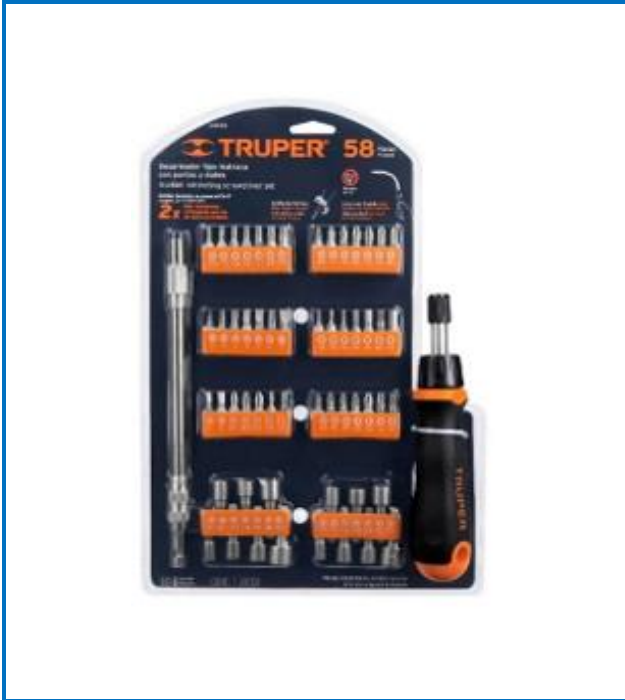

SKU

MEDIDA

1018220

- 09 PTAS PLANAS 3 A 7MM
- 10 PTAS CRUZ PH0 A PH3
- 09 PTAS TORX T10 A T140
- 07 PTAS POZIDRIV PZ0 A PZ3
- 07 PTAS HEXAGONAL 2 A 6MM
- 14 DADOS 5 A 11MM
- 01 EXTENSION FLEXIBLE
- 01 DESTORNILLADOR MATRACA

PROBADOR DE CIRCUITOS CORRIENTE ALTERNA, 14 cm

TRUPER



SKU

MEDIDA

1013988

100 - -500 V

- Ideal para circuitos de corriente alterna de 100-500 V
- Punta de acero al cromo vanadio y mango acrílico transparente, aislado para mayor seguridad
- Indicador de luz con fusible
- Clip tipo pluma para portar en el bolsillo
- Funciona al tocar

MAGNETIZADOR-DESMAGNETIZADOR

TRUPER

SKU

MEDIDA



1014141

(+) / (-)

- Para magnetizar o desmagnetizar herramientas y pequeñas piezas de acero
- Ideal para desarmadores y puntas que requieran una mayor o menor potencia magnética

MARTILLOS – COMBOS – LLAVES REGULABLES – CAIMANES – REMACHADORAS – TIJERAS - FORMONES

COMBO OCTAGONAL CORTO MANGO FIBRA DE VIDRIO

SKU	MEDIDA
-----	--------

1010851	16 OZ
1010852	20 OZ

TRUPER



COMBO OCTAGONAL CORTO MANGO FIBRA DE VIDRIO

SKU	MEDIDA
-----	--------

1019883	3 LB
1016536	4 LB

TRUPER



COMBO OCTAGONAL LARGO 36" MANGO FIBRA DE VIDRIO

TRUPER



SKU MEDIDA

1019884	6 LB
1016538	8 LB
1016540	10 LB
1016542	12 LB
1016546	16 LB

LLAVE REGULABLE (FRANCESA) C/GRIP CROMADA

TRUPER



SKU MEDIDA

1015509	6"
1015510	8"
1015511	10"
1015512	12"

LLAVE REGULABLE (FRANCESA) PAVONADA

PRETUL



SKU MEDIDA

112822	6"
112823	8"
112824	10"
112825	12"

LLAVE REGULABLE (FRANCESA) CROMADA

PRETUL



SKU MEDIDA

112814	6"
112815	8"
112816	10"
112817	12"

LLAVE COMBINADA PUNTA CORONA EXPERT MILIMETRICAS

TRUPER



SKU

MEDIDA

1015610	6mm
1015611	7mm
1015612	8mm
1015613	9mm
1015614	10mm
1015615	11mm
1015616	12mm
1015617	13mm
1015618	14mm
1015619	15mm
1015620	16mm
1015621	17mm
1015622	18mm
1015623	19mm
1015624	20mm
1015625	21mm
1015626	22mm
1015650	23mm
1015627	24mm
1015651	25mm

LLAVE STILSON INDUSTRIAL

TRUPER



SKU

MEDIDA

1015835	8"
1015836	10"
1015837	12"
1015838	14"
1015839	18"
1015840	24"
1015841	36"

LLAVE COMBINADA PUNTA CORONA EXPERT MILIMETRICAS

TRUPER



SKU

MEDIDA

1015515	11" / 280mm
---------	-------------

CAIMAN DE PRESION MORDAZA CURVA C/GRIP

SKU	MEDIDA
-----	--------

1017436	10"
---------	-----

TRUPER



CAIMAN DE PRESION MORDAZA CURVA CROMADO

SKU	MEDIDA
-----	--------

1017421	7"
1017423	10"

TRUPER



CAIMAN DE PRESION MORDAZA RECTA CROMADO

SKU	MEDIDA
-----	--------

1017424	10"
---------	-----

TRUPER



CAIMAN DE PRESION MORDAZA CADENA CROMADO

SKU	MEDIDA
-----	--------

1017438	8"
---------	----

TRUPER



REMACHADORA 10" PROFESIONAL

TRUPER



SKU	MEDIDA
-----	--------

1017960	3/32 – 5/32 – 1/8 – 3/16
1017961	3/32 – 5/32 – 1/8 – 3/16 + 60 Remaches.

REMACHADORA TIPO ACORDEON

TRUPER



SKU	MEDIDA
-----	--------

1017962	3/32 – 1/8 – 5/32 – 3/16 – 1/4
---------	--------------------------------

REMACHADORA 10"

TRUPER



SKU

MEDIDA

1017962

3/32 – 1/8 – 5/32 –
3/16 – 1/4

TIJERA DE AVIACIÓN CORTE DERECHO.

SKU

MEDIDA

1018535

9 1/2"

- Hojas forjadas de acero al cromo molibdeno 2X más resistentes al desgaste que las de acero al carbono
- Recubrimiento niquelado para mayor resistencia a la corrosión
- Mangos ergonómicos confortables de color verde para fácil identificación de tipo de corte
- Ideal para cortar cobre, acero y acero inoxidable

TRUPER

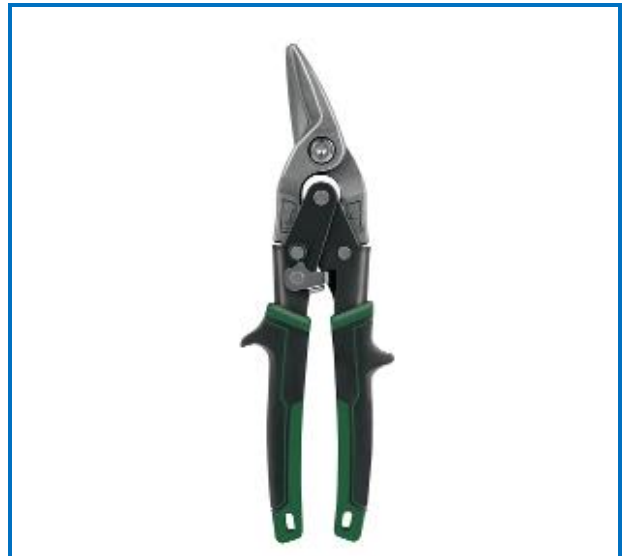

TIJERA DE AVIACIÓN CORTE RECTO

SKU	MEDIDA
-----	--------

1018531	9 1/2"
---------	--------

- Hojas forjadas de acero al cromo molibdeno 2X más resistentes al desgaste que las de acero al carbono
- Recubrimiento niquelado para mayor resistencia a la corrosión
- Mangos ergonómicos confortables de color amarillo para fácil identificación de tipo de corte
- Ideal para cortar cobre, acero y acero inoxidable.

TRUPER

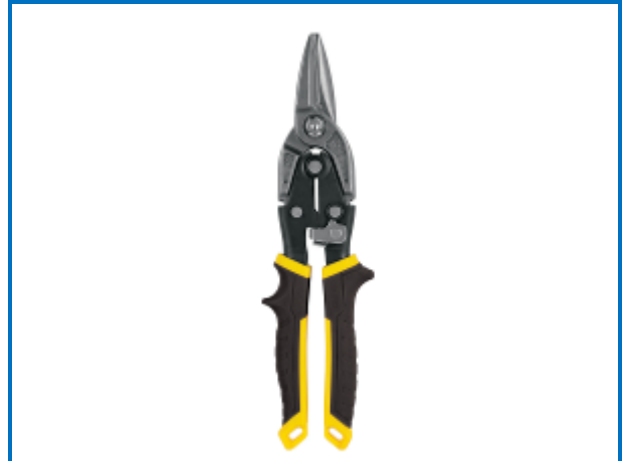

FORMON MANGO PLASTICO

PRETUL



SKU	MEDIDA
-----	--------

1121656	1/2"
1121650	1/4"
1121668	1"
1121662	3/4"
1121653	3/8"
1121659	5/8"

TRUPER

SKU

MEDIDA



1017759

1" - 3/4" - 1/2"

INSTRUMENTOS DE MEDICION

HUINCHA MEDIR RESISTENTE IMPACTOS

SKU	MEDIDA
-----	--------

1014577	3M
1014578	5M
1014579	8M

TRUPER



HUINCHA MEDIR INDUSTRIAL RESISTENTE IMPACTOS

SKU	MEDIDA
-----	--------

1012695	5.5M X 25MM
---------	-------------

TRUPER



HUINCHA MEDIR C/GANCHO MAG

SKU	MEDIDA
-----	--------

10NXCM03MT	3M
10NXCM05MT	5M
10NXCM08MT	8M
10NXCM10MT	10M

TRUPER



NIVEL ALUMINIO ECO

PRETUL



SKU	MEDIDA
-----	--------

1122454	12"
1122456	14"
1122458	18"
1122460	24"

- Cuerpo de aluminio resistente a la corrosión.
- Gotas resistentes a la abrasión y al impacto que permiten una fácil lectura desde ángulos 0° y 90°.
- Borde continuo para trazar.

NIVEL PROFESIONAL MAGNETICO

TRUPER



SKU	MEDIDA
-----	--------

1014626	24"
---------	-----

- Cuerpo robusto de aluminio de uso rudo tipo vigueta con protecciones de TPR contra impactos
- Gotas de alta visibilidad que permiten una fácil lectura desde ángulos 0°, 45° y 90°
- Ventana de vista superior con gota aumentada
- Superficies maquinadas para mayor precisión
- Borde continuo para trazar

NIVEL DE HILO

SKU	MEDIDA
1017058	3"

TRUPER



NIVEL DE HILO TIZALÍNEAS 30 METROS PLÁSTICO CON GIS Y NIVEL

SKU	MEDIDA
1018579	30 metros

TRUPER



ESCUADRA FALSA

SKU	MEDIDA
-----	--------

1014382	10"
---------	-----

TRUPER



ESCUADRA PARA CARPINTERO

SKU	MEDIDA
-----	--------

1014376	12"
---------	-----

- Reglas fabricadas en acero Inoxidable.
- Graduación (milímetros y pulgadas) estampada en acero.
- Mangos de aluminio. Ideal para marcar y trazar ángulos de 45° o 90° y verificar la cuadratura de las piezas

TRUPER

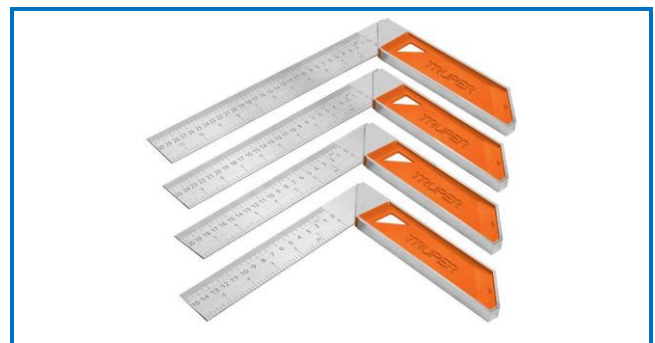

ESCUADRA PARA CARPINTERO

SKU	MEDIDA
-----	--------

1014386	8X12"
1014384	16X24"

- Graduaciones (centímetros y pulgadas) estampadas en acero
- Cantos rectificadas que permiten tener una desviación máxima de 0.18 mm.

TRUPER



SKU	MEDIDA
-----	--------

10104024	12"
----------	-----

TRUPER



- Cuerpo ligero de aluminio
- Graduación impresa por ambos lados en alto contraste para fácil.
- Medidas en sistema métrico y standard.
- Para medición de ángulos (0° a 90°), uso con nivel y como guía de corte

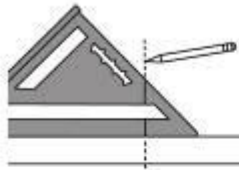

Guía de trazado de perpendiculares

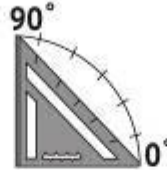

Medición de ángulos

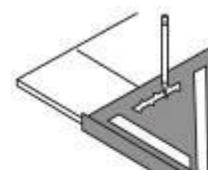

Muestras para facilitar trazado

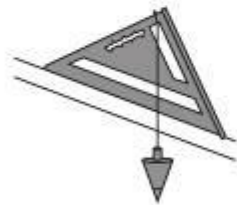

Uso con plomada

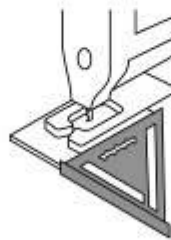

Uso como guía de corte



Uso con nivel

SERRUCHO – ARCOS – SIERRAS

SERRUCHO COSTILLA

TRUPER



SKU

MEDIDA

1018165

12"

- Costilla y hoja de acero alto carbono 1070 para óptima resistencia al desgaste
- Mango más cómodo que facilita el ángulo de corte

SERRUCHO MURO VOLCANITA

SKU

MEDIDA

1018174

6"

- Hoja de acero SK5 resistente al desgaste
- Dientes de mayor dureza con triple filo para cortes rápidos, con menor esfuerzo
- Punta afilada para iniciar el corte rápidamente en paneles de yeso y penetrar sin taladrar
- Mango con grip ergonómico antiderrapante de doble inyección
- Ideal para plafón y muros de yeso

TRUPER



SERRUCHO RAPIDO C/MANGO GRIP

TRUPER



SKU

MEDIDA

10101870

22"

- Fabricado en acero alto carbono templado.
- Hoja gruesa no se dobla al cortar con cómodo mango cubierto de TPR antiderrapante para un agarre seguro.
- Dientes con triple filo para cortes más rápidos, con diseño de mango para trazar ángulos a 90° y 45°.

ARCO PROFESIONAL PESADO

SKU	MEDIDA
-----	--------

1010232	12"
---------	-----

- 2x Más pesado que otras marcas, mayor facilidad para cortar y menos cansancio
- Mango ergonómico
- Asa secundaria para mayor control
- Dos posiciones de segueta: 0° y 45°
- Segueta 12" (30 cm) bimetálica de 18 dpp, Truper Expert, incluida.

TRUPER



ARCO 12" DE SOLERA PARA SEGUETA

PRETUL



SKU	MEDIDA
-----	--------

1120017	12"
---------	-----

- Mango fabricado en ABS.
- Compacto y resistente.
- Mayor tensión de ajuste para cortes más rápidos y precisos.
- Dos posiciones de segueta 90° y 180°.
- Tuerca de ajuste de tensión.

ARCO 12" PROFESIONAL TUBULAR DE ACERO PARA SEGUETA

TRUPER



SKU	MEDIDA
-----	--------

1120017	12"
---------	-----

- Mango ergonómico inyectado en aluminio
- Asa secundaria para mayor control
- Dos posiciones de segueta: 0° y 90°
- Segueta 12" (30 cm) bimetálica de 18 dpp, Truper Expert, incluida.

MINI ARCO 12" DE ALUMINIO PARA SEGUETA

TRUPER



SKU

MEDIDA

1010236

12"

- Mango ergonómico para mejor agarre.
- Ligero y compacto para cortes en espacios reducidos

REPUESTO HOJA SIERRA

EURODRILL



SKU

MEDIDA

780808

218 HE18 TPI (18 dientes)

780877

224 HE 24TPI (24 dientes)

JUEGO DE 16 SEGUETAS PARA CALADORA ZANCO "T" CORTE RECTO

TRUPER



SKU

MEDIDA

1016129

16 PZAS

- Seguetas para cortes en madera fabricadas en acero al carbono (HCS)
- Seguetas para cortes en metales, plásticos y aluminio fabricadas en acero alta velocidad (HSS)
- Zanco "T" compatible con otras marcas del mercado
- Para sierras caladoras modelos CALA-NX6, CALA-A5, CALA-A4, CALA-A3 marca Truper® y CALA-P3 marca Pretul®.

CALAFATERAS – SILICONAS – ADHESIVOS – CINTAS – AMARRAS PLASTICAS

CALAFATERA TIPO ESQUELETO REFORZADA

SKU	MEDIDA
-----	--------

1017558	NA
---------	----

TRUPER



CALAFATERA TIPO ESQUELETO

SKU	MEDIDA
-----	--------

1017550	NA
---------	----

TRUPER



CALAFATERA TIPO ESQUELETO

SKU	MEDIDA
-----	--------

1122801	NA
---------	----

TRUPER



SILICONA ACETICA C/FUNG. 11. SELLOTEC



SKU	COLOR
76943972774330	BLANCO
76943972773823	TRANSPARENTE

SILICONA NEUTRA C/FUNG.20. SELLOTEC



SKU	COLOR
76943972813040	BLANCO

SILICONA NEUTRA. SELLOMAC



SKU	COLOR
76944001262856	TRANSPARENTE

SELLADOR TAPA GOTERAS. SELLOTEC



SKU	COLOR
76943972805364	GRIS

ADHESIVO MONTAJE. SELLOMAC



SKU	COLOR
76944001260140	BLANCO

SELLADOR DE POLIURETANO

SKU	COLOR
1012905	GRIS

TRUPER



SILICONA ALTA TEMPERATURA

TRUPER



SKU

MEDIDA / COLOR

1017567

85 g / Negro

1017566

85 g / Rojo

- No inflamable, no presenta cuarteaduras después del secado
- Vulcanizan a temperatura ambiente
- Resiste temperaturas de -50° C a 250° C
- Se mantienen flexibles aun después de su aplicación
- Evita fugas y filtraciones

SILICONA SELLADOR

TRUPER



SKU

MEDIDA / COLOR

1018568

85 g / Blanca

- Buena adherencia en superficies lisas
- Anti-hongos, fungicida resistente a la humedad, ácidos y sulfuro
- Fácil aplicación sin escurrimientos
- Para superficies como cerámica, porcelana, vidrio, azulejo, formica, aluminio, acero inoxidable, madera

SILICONA SELLADOR

TRUPER



SKU

MEDIDA / COLOR

1017562

85 g / Translucida

- Buena adherencia en superficies lisas
- No cambia de color
- No se despegó o reseca
- Fácil aplicación sin escurrimientos
- Para superficies como vidrio, aluminio, cerámica, porcelana, madera, hierro

ESPUMA EXPANSIVA POLIURETANO

SKU	MEDIDA
7694397280918	500 ml
76943972773250	750 ml

- Espuma de Poliuretano para sellar, rellenar y aislar.
- Excelente adherencia a diferentes materiales.
- Gran Poder de expansión
- Resistente a Cambios de temperaturas
- Se puede cortar y empastar una vez fraguado
- Aislante térmico
- Aísla y sella contra la humedad y el frío
- Excelente estabilidad no encoge ni post-expande
- Lista para usar

SELLOMAC



ADHESIVO MONTAJE ADIÓS CLAVOS

SKU	MEDIDA
10102281	140 g

- Adhesivos extrafuertes que sustituyen el uso de clavos y tornillos
- Proporciona un pegado resistente, sin orificios, sin daños en paredes
- Una vez seco puede lijarse y pintarse
- Resistente a la humedad y a temperaturas de 0° a 80° C
- Para usos múltiples

TRUPER



CINTAS DE ALUMINIO 48 mm X 10 m

TRUPER



SKU

MEDIDA

1012611

10 m x48 mm

- Fabricadas de aluminio con adhesivo hot melt
- Protegen y aíslan
- Se adhieren a superficies irregulares
- Ideales para reparaciones temporales en superficies de metal, aparatos de calefacción y refrigeración
- Para uso en interiores y exteriores

CINTAS PARA DUCTO, 0.16 mm DE ESPESOR

PRETUL



SKU

MEDIDA

1120529

30 m

- Fabricadas de polietileno, reforzadas con malla de algodón
- Adhesivos hot melt

CINTAS PARA DUCTO 0.19 MM DE ESPESOR

TRUPER



SKU

MEDIDA

1012586

10 metros

- Fabricadas de polietileno, reforzadas con malla de algodón
- Adhesivos hot melt

CINTA MASKING TAPE

NEXXO



SKU	MEDIDA
12NX2218MT	¾"-18mmx40mt
12NX2224MT	1"-24mmx40mt
12NX2236MT	1 ½"-36mmx40mt
12NX2248MT	2"-48mmx40mt

- Se utiliza para la protección de uniones de pared, muebles y cielos a la hora de pintar.

CINTA HUINCHA AISLANTE NEGRA

TRUPER



SKU	MEDIDA
1012501	9 m x 19 mm

- Cintas fabricadas en PVC con base de adhesivo acrílico
- Retardantes de flama
- Inhiben la corrosión de conductores eléctricos
- Aislamiento eléctrico en alambres y cables con capacidad nominal de hasta 500 V

CINTA TEFLON

TRUPER



SKU	MEDIDA
1012520	½" x 7 m
1012521	¾" x 7m

- Fabricadas de teflón. No permiten la generación de hongos y bacterias.
- Gran elasticidad.
- De fácil colocación
- Ideales para sellar roscas de cobre, latón, acero galvanizado, acero inoxidable, aluminio, PPR, CPVC, PVC, ABS y plásticos en general.

CINTA DELIMITADORA "PRECAUCIÓN"

TRUPER



SKU

MEDIDA

1012583

75 mm x 305m

- Cintas de polietileno
- Alta resistencia a la fricción
- Elongación de 400% antes de romperse

AMARRAS PLÁSTICAS

SKU

MEDIDA

750512	3.2X140mm
750524	3.6X150mm
750533	3.6X250mm

IMPORPER



SKU

MEDIDA

12NXAC10025N	2.5X100 mm
12NXAC15025N	2.5X150 mm
12NXAC20048N	4.8X200 mm
12NXAC30048N	4.8X300 mm

NEXXO



HERRAMIENTAS DE EXCAVACIÓN.

CHUZO HEX. ESCOPLA PTA.

SKU	MEDIDA
-----	--------

1010756	150 cm
1010762	175 cm

- Fabricada en acero con doble tratamiento térmico
- Para perforar superficies duras de tierra, piedra o concreto y demoler, romper o cortar raíces de árboles

TRUPER



CINCELES DE CORTE FRÍO CON GRIP

SKU	MEDIDA
-----	--------

1012172	3/4" X 12"
1012175	7/8 X 12"
1012181	1" X 12"

- Fabricados en acero al cromo vanadio.
- Grip ergonómico de TPR que absorbe vibraciones y protege la mano de golpes accidentales.
- Filo endurecido para mayor resistencia a impactos.

TRUPER



CINCELES HEXAGONALES PARA CONCRETO

SKU	MEDIDA
-----	--------

1013050	30 cm
1013053	36 cm

- Fabricadas en acero alto carbono con tratamiento térmico diferenciado en punta y cabeza con puntas en forma de diamante para rápida penetración
- Recubrimientos en pintura poliéster color naranja.

TRUPER



BARRETILLAS DE UÑA, SECCIÓN HEXAGONAL 3/4"

SKU	MEDIDA
1010853	3/4" x 45 cm
1010856	3/4" x 60 cm
1010859	3/4" x 75 cm
1010862	3/4" x 90 cm

TRUPER



RASPADOR FORJADO CON MANGO

SKU	MEDIDA
1018652	Ancho hoja: 7" Largo total: 160 cm

TRUPER



- Recomendado para uso agrícola
- Cabeza de acero
- Mango largo de madera

Ideales para nivelar, limpiar y acondicionar terrenos antes de la siembra

PALA IRRIGACIÓN T-2000, MANGO LARGO 45"

TRUPER



SKU

MEDIDA

1017177

Espesor: 1.5 mm
Largo Cabeza: 52 cm
Ancho Cabeza: 23 cm
Largo total: 57" (145 cm)

- Cabeza de acero al carbono
- Mango largo de madera con acabado laqueado
- Collar reforzado que permite un ensamble robusto
- Hombros rolados atrás.

PALA ESPADÓN T-2000, PUÑO "Y"

TRUPER



SKU

MEDIDA

1017163

Espesor: 1.5 mm
Largo Cabeza: 61 cm
Ancho Cabeza: 15 cm
Largo total: 44 ½" (112 cm)

- Cabeza de acero al carbono
- Mango de madera con puño "Y" Comfort Grip
- Collar reforzado que proporciona un ensamble robusto
- Hombros atrás
- Ideal para cavar zanjas.

PALA REDONDA T-2000, PUÑO "Y"

TRUPER



SKU

MEDIDA

1017160

Espesor: 1.3 mm

Largo Cabeza: 49 cm

Ancho Cabeza: 21 cm

Largo total: 40 ½" (103 cm)

- Cabeza de acero al carbono
- Mango de madera con puño "Y" Comfort Grip
- Collar reforzado que permite un ensamble robusto
- Hombros rolados atrás.

HERRAMIENTAS DE PINTURA

BROCHA MANGO GRIP.

SKU	MEDIDA
-----	--------

1121526	2"
1121528	3"
1121529	4"

SKU	MEDIDA
-----	--------

1014483	2"
1014485	3"

SKU	MEDIDA
-----	--------

12NXBGRP15	1 ½"
12NXBGRP10	1"
12NXBGRP25	2 ½"
12NXBGRP20	2"
12NXBGRP30	3"
12NXBGRP40	4"

PRETUL



TRUPER



NEXXO (ECO)



SKU	MEDIDA
-----	--------

12NXBGRP15	1 ½"
12NXBGRP10	1"
12NXBGRP25	2 ½"
12NXBGRP20	2"
12NXBGRP30	3"
12NXBGRP40	4"

NEXXO (PREMIUM)



RODILLO CORTA GOTA

SKU	MEDIDA
-----	--------

12NXRODFIB	18 cm
------------	-------

NEXXO



ESPATULAS

FLEXIBLE MAGO MADERA. TRUPER



SKU	MEDIDA
-----	--------

1014447	1"
1014449	3"
1014450	4"

ESPATULA PLASTICA. TRUPER



SKU	MEDIDA
-----	--------

1014443	2"
1014444	3"

ESPATULA MULTIUSO 7 EN 1. NEXXO



SKU	MEDIDA
-----	--------

12NXESP5X1	NA
------------	----

EXTENSION TELESCOPICA.

SKU	MEDIDA
-----	--------

12NXEME24T	2,4 mts
------------	---------

NEXXO



REVOLVEDOR DE PINTURA

SKU	MEDIDA
-----	--------

1015824	NA
---------	----

TRUPER



RASPADOR PINTURA

TRUPER



SKU

MEDIDA

1016951

NA

1016952

1 ½" (38 mm)
5 NAVAJAS

REPUESTO PARA RASPADOR



LIJAS

SKU

MEDIDA

38C01MAD120P	Grano 120
38C01MAD100P	Grano 100
38C01MAD080P	Grano 80
38C01MAD060P	Grano 60
38C01MAD050P	Grano 50
38C01MAD040P	Grano 40

PLIEGO LIJA MADERA N°278. NEXXO



SKU

MEDIDA

38C02FIE100P	Grano 100
38C02FIE060P	Grano 80
38CO2FIE080P	Grano 60

PLIEGO LIJA METAL N°267. NEXXO



LUBRICANTES Y MANTENIMIENTO

GRASA LUBRICANTE MULTIUSO.

SKU	MEDIDA
-----	--------

1012783	450 g
---------	-------

USOS:

Chasis, sistemas de suspensión, baleros, equipo agrícola industrial de construcción, engranes sin fin, discos de embrague

TRUPER



ACEITE MULTIUSO CORROSION.

SKU	MEDIDA
-----	--------

1016711	30 ml (1 oz)
---------	--------------

USOS:

Protegen contra oxidación y corrosión-Limpian superficies de metal

TRUPER



LUBRICANTE AFLOJA TODO WT400.

SKU	MEDIDA
-----	--------

10101975	400 ml
----------	--------

USOS:

Limpian superficies con polvo, grasa y pegamento, útiles en el área automotriz, industrial, marina y en el hogar, su uso lubricante sirve para la mayoría de los materiales, excepto policarbonato y poliestireno

TRUPER



CARGA

ESLINGA TENSOR CARGA CON MATRACA 2 PIEZAS

TRUPER



SKU	MEDIDA
1019282	1125 kg (resistencia a la ruptura)
1019281	675 kg (resistencia a la ruptura)

ESPECIFICACIONES:

- Cinta 100% poliéster, no se deforma
- Gancho tipo S
- Sistema para aplicar máxima tensión con mínimo esfuerzo
- Mecanismo de rápida liberación

SUJECIÓN Y ENGRAPADO

ENGRAPADORA TIPO PISTOLA

TRUPER

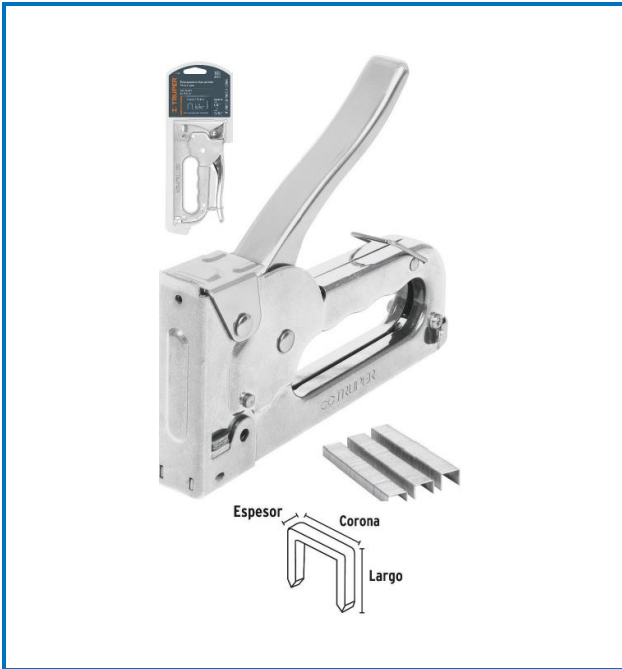

SKU

MEDIDA

1017963

1/4"
5/16"
3/8"

GRAPAS

1017970

1/4" (6mm)

1017971

5/16" (8 mm)

1017967

3/8" (10 mm)

CLAVO TAPICERO DORADO

IMPORPER



SKU

MEDIDA

750502

1/2" (Bolsas 100 un.)

- Ideal para usar en muebles, arreglar detalles y otros trabajos artesanos

GANCHO MULTIUSO ACERO GRIP

SKU	MEDIDA
-----	--------

1011104	10x15 cm
1011105	13 x12 cm

- Fabricado en acero al carbono recubierto de PVC que no daña los objetos

TRUPER



JARDINERIA

ARCO JARDINERO TUBULAR

TRUPER

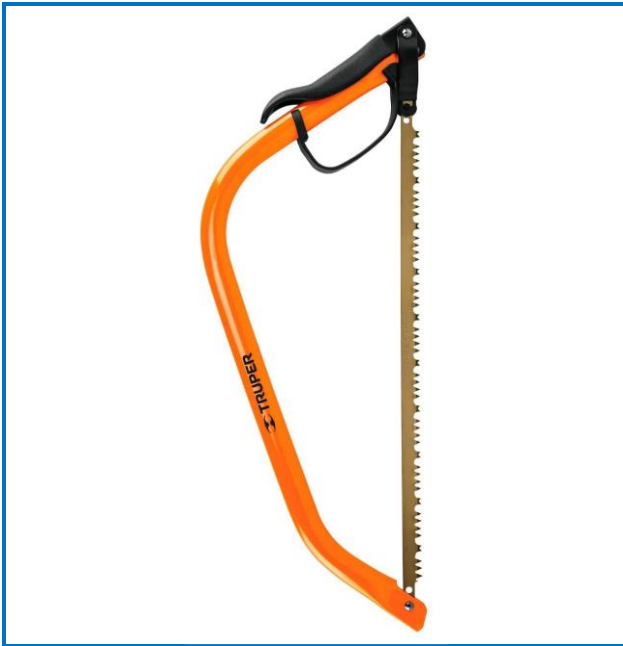

SKU

MEDIDA

1010258

24"

- Seguetas de acero SK5 con dientes templados.
- Dentado tipo americano, diseñado para cortar madera verde y húmeda.
- Mango con protector de PVC, diseñado para evitar que la mano se resbale

SERRUCHO DE PODA 16", CON GANCHO, 5 DPP

TRUPER



SKU

MEDIDA

1018179

16"

- Hoja de acero SK5 resistente al desgaste, curva para cortes rápidos
- Dientes más definidos para mayor velocidad en el corte
- Mango robusto de PVC
- Barrenos que ayudan a expulsar el material durante el corte
- Gancho tope para facilitar los cortes

SERRUCHO DE PODA EN ALTURA

TRUPER

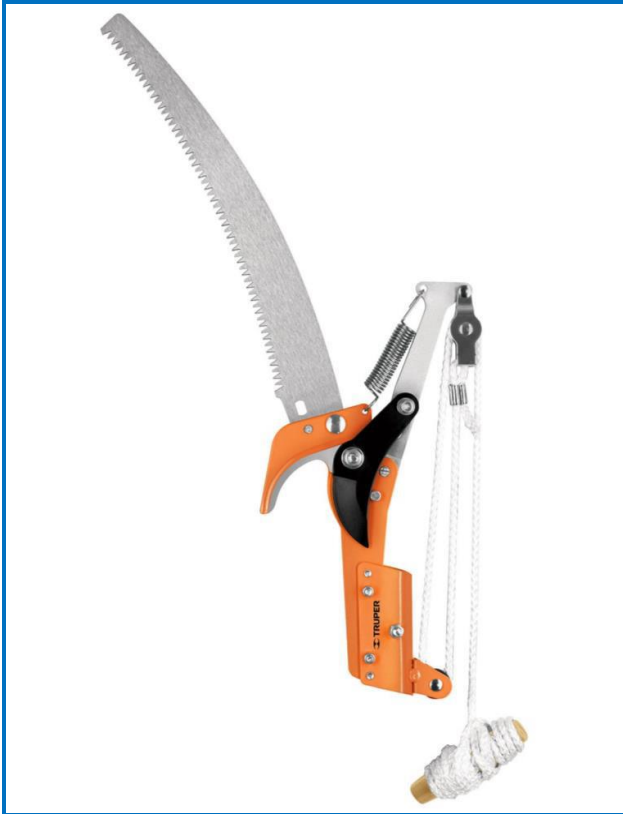

SKU

MEDIDA

1018401

14" (36 cm)

- Hoja totalmente templada fabricada en acero SK5, dientes con triple filo para cortes rápidos
- Cuchilla de paso templada fabricada en acero al carbono.

MANGO TELESCÓPICO PARA TR-82, ALUMINIO

SKU

MEDIDA

1016000

1,3 a 2,4 m

- Se extiende hasta 2.4 m
- Uso auxiliar de alcance para conectar con serruchos de poda Truper.

TRUPER

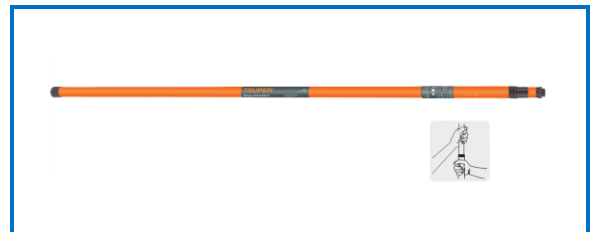

TIJERA PODA FORJADA CURVA. PRETUL



SKU

MEDIDA

1123104

8"

- Cuchilla fabricada en acero templado.
- Cabeza angulada que ayuda a reducir la fatiga.
- Mangos con cubierta antiderrapante.
- Recomendada para cortar flores, plantas, ramas y tallos.

TIJERA PODA DE ALUMINIO CUCHILLA DE PASO. TRUPER



SKU

MEDIDA

1018453

8"

- Construida en aluminio inyectado con hojas de acero al alto carbono.
- Mangos recubiertos de vinil para confort.
- Recomendada para cortar flores, plantas, ramas y tallos.

RASTRILLO JARDINERO, 14 DIENTES

SKU	MEDIDA
-----	--------

1125054	13 1/2" (34 cm) Cabeza 48" (122 cm) Mango
---------	--

- Cabeza soldada fabricada en acero.
- Mango de madera.
- Ideal para distribuir materiales de manera uniforme, aflojar y romper tierra compactada.
- Para recoger hojas, hierba y desechos del jardín.

PRETUL



RASTRILLO JARDINERO, 16 DIENTES

SKU	MEDIDA
-----	--------

1017880	16 1/2" (42 cm) Cabeza 60" (152cm) Mango
---------	---

- Cabeza de acero forjada en una sola pieza con 16 dientes
- Mango de madera
- Ideal para distribuir materiales de manera uniforme
- Para recoger hojas, hierba y desechos del jardín.

TRUPER



AZADÓN C/MANGO FIBRA

TRUPER



SKU

MEDIDA

1010615

1,8 Lb mango fibra 54"

- Cabeza forjada en una sola pieza con nervio central para mayor resistencia al impacto y disminución de la vibración, acabado pulido y preafilado.
- Mango de fibra de vidrio más resistente que los mangos de madera con inserto cónico para acople preciso para mayor seguridad.
- Ideal para aflojar y preparar el terreno para la siembra.
- Uso agrícola y hortícola.

HERRAMIENTAS JARDÍN 4 PIEZAS

SKU

MEDIDA

1015030

6"

- Fabricadas en acero carbono.
- Mangos fabricados en madera de fresno.
- Casquillos metálicos que refuerzan el encabezado

TRUPER



MANGUERA RIEGO REFORZADAS 3 CAPAS, CONEXIONES PLÁSTICAS. TRUPER



SET MANGUERA REFORZADA CON PISTOLA. TRUPER



MANGUERA DE NIVEL. TRUPER



SKU	MEDIDA
-----	--------

1016050	1/2" 10 mts
1016052	1/2" 20 mts

- Mangueras de PVC fabricadas en 3 capas con refuerzo de tramado radiales resistentes a la alta presión.
- Conexiones plásticas
- Franjas anti-torceduras

SKU	MEDIDA
-----	--------

1019750	1/2" 15 mts
---------	-------------

- Manguera de 3 capas.
- 5 costillas internas que permiten el flujo de agua aún con la manguera doblada.
- Conexiones plásticas.
- Pistola plástica con recubrimiento, 2 funciones.

SKU	MEDIDA
-----	--------

1019863	1/2"
---------	------

- Fabricada en PVC flexible transparente
- Resistente al uso a la intemperie
- Uso en construcción, ideal para marcar alturas al mismo nivel
- Uso general para conducción de líquidos no abrasivos

PISTOLA PARA RIEGO DE 8 FUNCIONES PLÁSTICA CON RECUBRIMIENTO

SKU	MEDIDA
-----	--------

1018482	NA
---------	----

- Clip para flujo continuo, permite que el agua fluya sin apretar constantemente.
- Uso en jardinería, para regar plantas y limpieza.

TRUPER



ASPERSOR GIRATORIO 3 BRAZOS DE ALUMINIO CON BASE METALICA

SKU	MEDIDA
-----	--------

1010303	NA
---------	----

- Base metálica.
- 3 Brazos de aluminio con mayor resistencia que aseguran una cobertura total del área de riego.

TRUPER



ASPERSOR CON ESTACA METALICA

SKU	MEDIDA
-----	--------

1010303	NA
---------	----

- Cabeza de aspersor plástico de pulsaciones.
- Estaca metálica con dos vías para conectarse en serie con empaque integrado.
- Clip de límite de riego.

TRUPER



PORTAMANGUERAS PLÁSTICO

TRUPER



SKU

COLOR

1010387

NARANJO

- Fabricados en polipropileno alto impacto
- Diseñados para fijarse a la pared
- Soportan 8 kilos de manguera

CONECTOR ACOPLE

SKU

MEDIDA

1012727	½" CONECTOR HEMBRA
1012726	½" CONECTOR MACHO

- Fabricado en polipropileno.
- Conexión rápida y automática.
- Sistema click.

TRUPER



HILO REDONDO DESBROZADORA

TRUPER



SKU

MEDIDA

1017607 12 mt x ϕ 2.4 mm

1017629 12 mt x ϕ 2.7 mm

- Alta resistencia al desgaste y quebraduras
- Ideales para todo tipo de terrenos.

ATOMIZADOR SPRAY

SKU

MEDIDA

1055938

1 LTS

- Diseños ergonómicos para un mejor agarre.
- Sellos antifugas.
- Gatillos suaves que reducen la fatiga.
- Boquillas regulables tipo cono y jet.

KLINTEK



SILLA PLEGABLE POLIESTER ACERO

TRUPER



SKU

MEDIDA

1061025
 Altura:91 cm
 Base: 54 cm
 Fondo: 44 cm

- Estructura de acero y tela de poliéster con 4 tapas
- 2 Reposabrazos, 1 portavasos
- Práctico estuche para almacenar y transportar
- Ideal para cualquier evento en exteriores

LIMPIEZA Y HOGAR

BARRE AGUA CON BASTÓN DE MADERA.

KLINTEK



SKU

MEDIDA

1057016

NA

- Cuerpo de lámina y hule suave que no raya los pisos.
- Bastón de madera de 120 cm (incluído)
- Ideal para eliminar exceso de agua en el piso.

PALA PLASTICA RECOGEDOR C/MANGO.

KLINTEK

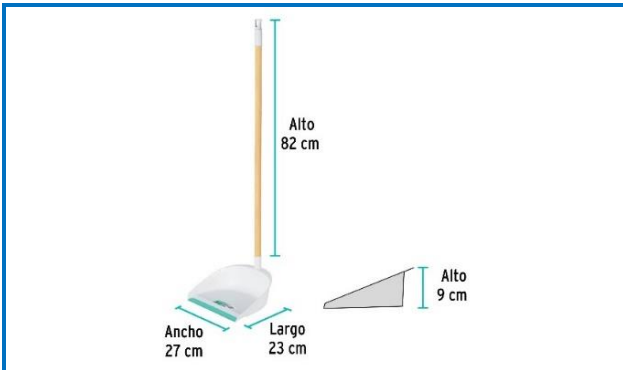

SKU

MEDIDA

1057024

23 cm x 27 cm x 9 cm

- Goma que ayuda a recoger todo el polvo sin dejar residuos
- Con ranuras que limpian las cerdas de la escoba

KLINTEK

SKU

MEDIDA



1057065

40 x 40 cm

- Fabricada de 100% Poliester
- No raya las superficies
- Uso en seco: para pulir y sacudir
- Uso en húmedo: gran absorción para limpieza en general
- Libre de pelusa

CARTONEROS Y CORTADORES

CARTONERO ECO

PRETUL



SKU

MEDIDA

1122396

6"

- Cuchilla de acero
- Seguro automático

CARTONERO CON GRIP

TRUPER



SKU

MEDIDA

1016977

6"

- Cuchilla de acero SK4
- Grip antiderrapante
- Seguro y cambio automático de cuchilla

ACCESORIOS AUTOMOTRICES

CABLE BATERIA PASA CORRIENTE, 3 M, CALIBRE 8 AWG

TRUPER



- Cable de aluminio revestido de cobre
- Mayor flexibilidad para fácil manejo, no se enredan
- Pinzas con pintura electrostática y mordazas de acero recubiertas de cobre
- Funda para fácil transporte y almacenamiento

SKU	MEDIDA
1017543	225 A

ELEMENTOS DE PROTECCIÓN

GUANTES DE SEGURIDAD

GUANTE NYLON C/POLIURETANO TRUPER



GUANTE NYLON C/NITRILO TRUPER



SKU

MEDIDA

1013292

M - G

- Alta sensibilidad y ajuste
- Procesos húmedos o secos
- Recubrimiento de poliuretano en palma

SKU

MEDIDA

1013295

M - G

- Fabricados de nylon
- Alta sensibilidad y ajuste
- Protección contra cortes
- Puño tejido
- Recubrimiento de nitrilo liso en palma

PROTECTOR DE OREJERA AJUSTABLE

TRUPER



SKU

MEDIDA

1014257

ESTANDAR

- Nivel de reducción de ruido: 18 dB (NRR)
- Altura ajustable
- Almohadilla para mayor confort

PROTECTOR FACIAL

TRUPER



SKU

MEDIDA

1014221

MICA:20X38,5 cm
Espesor 1 mm

- Mica de policarbonato flexible, antirayadura
- Resistente a impactos
- Abatimiento de 90°
- Ajuste de matraca

FAJA LUMBAR

TRUPER



SKU

MEDIDA

1014238

G

- Fabricadas de poliéster, elastano, nylon y polietileno
- Tirantes ajustables
- Flexibles para mayor comodidad
- Cierre con fijación hook and loop
- 4 varillas para soporte lumbar

RODILLERAS LIGERAS

TRUPER



SKU

MEDIDA

1012951

L

- Fabricadas en EVA (Etil-vinyl-acetato) y gel
- Ideales para superficies planas como azulejo y concreto
- Forro transpirable
- Ajuste con banda elástica

CONTROL DE ROEDORES

TRAMPA RATON MADERA

PRETUL

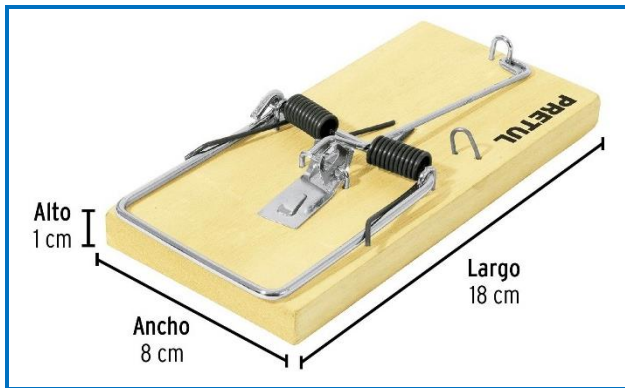

SKU

MEDIDA

1123710

7"

- Resorte tratado térmicamente para mayor presión
- Pedal de activación sensible al contacto
- Base fabricada en madera y componentes de acero resistentes y durables
- Requiere de una porción de alimento como carnada para atraer al roedor.